

Disponible
Exclusivamente para
Acrilamiento con
DVH 4+9+4

B-B Corte Vertical

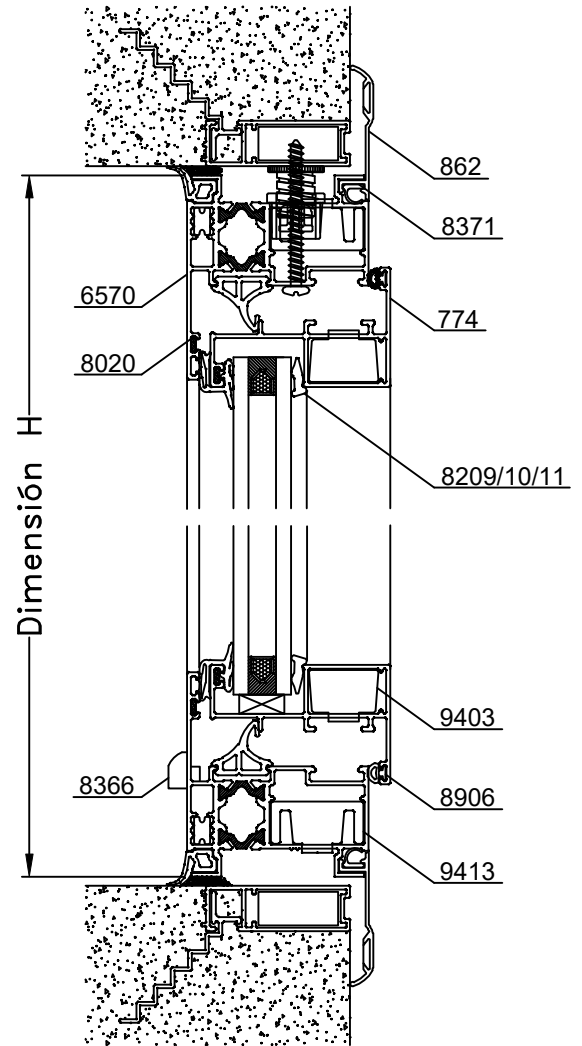

Opción de Banderola

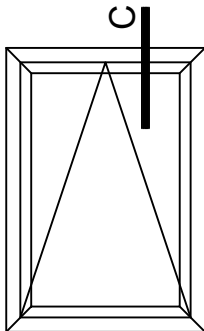

Disponible
Exclusivamente
para DVH 4+9+4

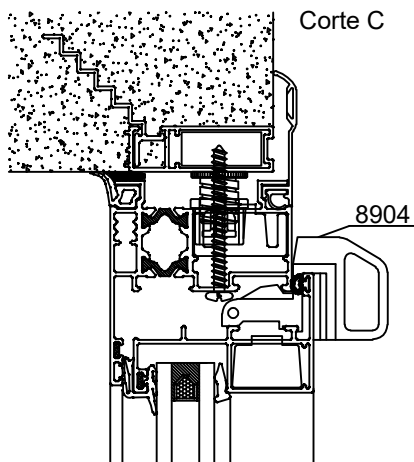

Opción Oscilo-Batiente en página 64

A-A Corte Horizontal

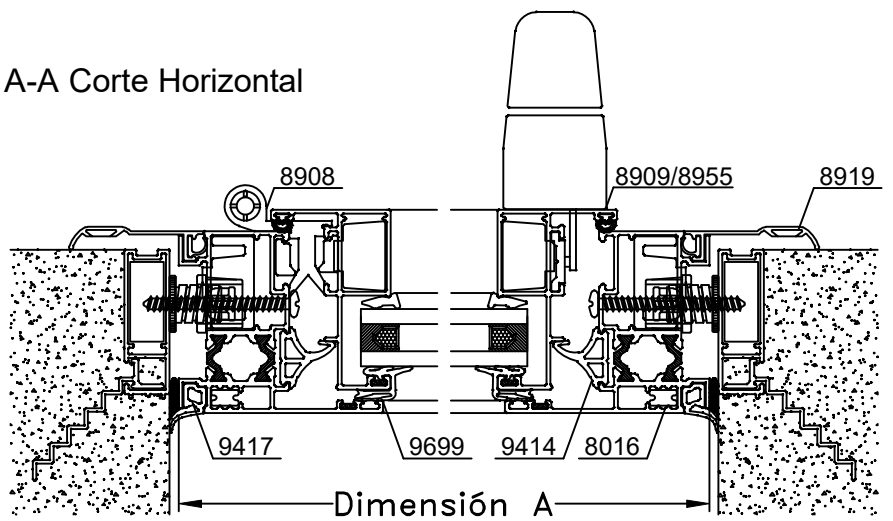

Escala 1:2.5

Tolerancia en Peso +/- 10%











21-03-18 **MEDITERRANEA-RPT.32**

Dimensiones de Corte				Ventana de Rebatir			Ventana Banderola		
Código	Peso Kg/m	Forma	Función	Cant.	Largo	Corte	Cant.	Largo	Corte
6570	1,37		Marco	2	A	45° 45°	2	A	45° 45°
				2	H	45° 45°	2	H	45° 45°
774	0,69		Hoja	2	A-61	45° 45°	2	A-61	45° 45°
				2	H-61	45° 45°	2	H-61	45° 45°
Varilla 9469 o Perfil 703	0,07 (Varilla) 0,16 (Perfil)		Varilla	2	Según Falleba	90° 90°	-	-	-

Dimensiones de Corte Contramarco: pág. 24

* Medidas en milímetros

Dimensiones de Corte Premarco: pág. 25

Detalle de Accesorios				De Rebatir	Banderola
Ítem	Código	Descripción	Forma	Cantidad	Cantidad
Esc. de Armado	9413	Esc. de Armado Mediterranea RPT E-25		4 Unidades	4 Unidades
	9403	Escuadra de Armado Hoja E-08		4 Unidades	4 Unidades
	8020	Esc. de Alineación AA - 107	-	4 Unidades	4 Unidades
	8016	Esc. de Alineación		4 Unidades	4 Unidades
Burlete Vidrio	9699	Burlete Exterior para Ventana de Rebatir Hoja Oculta		2A + 2H	2A + 2H
Cuña Vidrio	8209	Cuña Chica		2A + 2H	2A + 2H
	8210	Cuña Mediana			
	8211	Cuña Grande			
Burlete Hermetic.	8906	Burlete AEL Europeo		2A + 2H	2A + 2H
	9414	Burlete Cámara Compensada Europeo	-	2A + 2H	2A + 2H
Burlete Exterior	9417	Burlete Exterior Tapa de Sellado		2A + 2H	2A + 2H
Cierre	8909	Falleba Prima H-47 con Kit		1 Unidad	-
	8955	Falleba Nova H-86 con Kit			
	8904	Traba Banderola H-52		-	1 Unidad (*)
Brazo Sostén	8443	Brazo Sostén Banderola H-53	-	-	1 Par
Bisagra	8908	Bisagra H-61 de 2 piezas con Kit		2 Unidades	2 Unidades
Posic. de Hoja	8433	Sostén de hoja (H 44)	-	1 Unidad	1 Unidad
Tapa Desagüe	8366	Tapa Desagüe T-69		2 Unidades	2 Unidades

s/m: según medida.

Accesorios Contramarco: pág. 24 Premarco: pág. 25

(*) Para Anchos superiores a 800 milímetros se recomiendan 2 Unidades.